

Defender™ 530

User Manual

MesaLabs

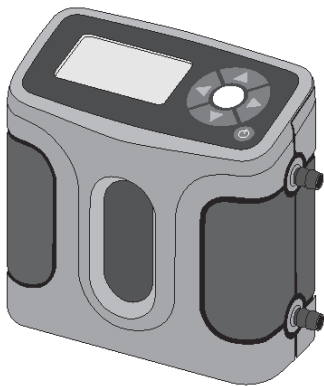

Defender 530 User Manual

Table of Contents

Introduction	1.0
Operation	2.0
Battery	2.1
Activation.....	2.2
Connections	2.3
Display Screen.....	2.4
Menu Navigation.....	2.5
Set Up	2.6
Measurements.....	2.7
Single.....	2.8
Burst	2.9
Continuous.....	2.10
Data Port	3.0
DryCal Pro Software	3.1
Defender Firmware Upgrades.....	3.2
Annual Maintenance and Calibration	4.0
Shipping	5.0
Storage	6.0
Defender 530 Specifications	7.0
Factory Default Settings	8.0
Limited Warranty	9.0
Troubleshooting Guide	10.0

Introduction	1.0
Operation	2.0
Data Port	3.0
Annual Maintenance and Calibration	4.0
Shipping	5.0
Storage	6.0
Defender 530 Specifications	7.0
Factory Default Settings	8.0
Limited Warranty	9.0
Troubleshooting Guide	10.0

1.0 Introduction

The Defender 530 measures both volumetric and standardized gas flow with a volumetric flow accuracy of 1% and standardized flow accuracy of 1.2% of reading. It uses our Proven DryCal Technology to measure volumetric gas flow and is manufactured in our accredited laboratory in Butler, NJ.

This manual will provide information needed to operate your Defender. If at any time you have questions regarding its operation, please contact Mesa Labs through our Web site (drycal.mesalabs.com) or call 973.492.8400 to speak with a member of our professional customer service staff.

Your Defender comes with the following:

- AC Power Adapter/Charger
- PC Serial Cable
- Leak Test Caps (2); Save for use during the Leak Test
- Calibration Certificate
- Manual

Carrying cases and accessories are available for purchase from Mesa Labs or your distributor.

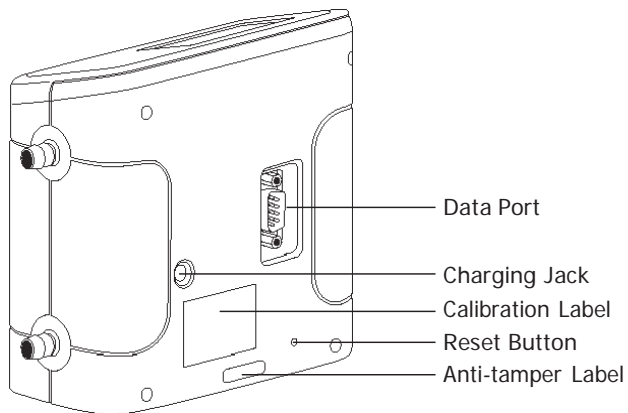
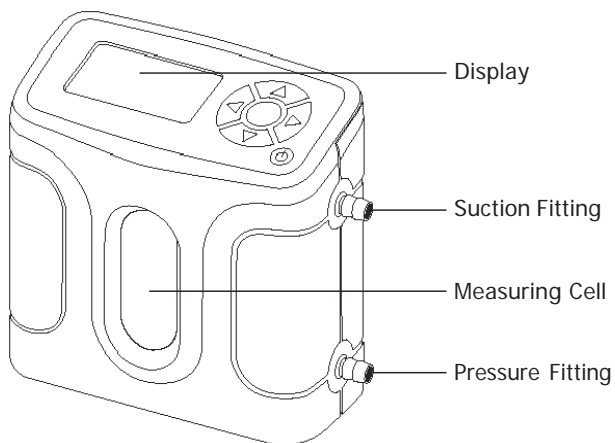

2.0 Operation

2.1 Battery

Your Defender battery is charged at the factory, but we recommend that you make sure it is fully charged before initial use.

- Connect the AC power adapter to the Defender's Charging Jack (DC In).
- Plug the AC power adapter into an AC outlet.

Initial charging should take about eight (8) hours. After the initial charge:

- You may continue to charge your Defender indefinitely simply by leaving it connected to the AC power adapter.
- Be sure to charge the battery at least every three (3) months, to maintain battery life.

The battery symbol on the LCD display indicates your Defender's battery charge condition. A shaded battery icon indicates a full charge. As the battery voltage drops, the indicator will empty in 20% increments.

Disposal:

In compliance with the European Union CE directive 2006/66/EC the battery in your Defender should be removed for recycling prior to disposal of the Defender. The battery in the Defender is a valve regulated sealed lead acid battery. Please note that opening the Defender may damage connections so this procedure should only be used for battery disposal.

Procedure:

Remove five Phillips head screws on the back of the Defender; one will be located under the calibration void label. Lift off the rear cover and

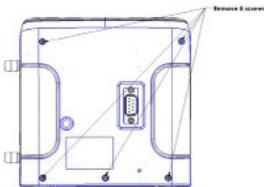

2.2 Activation

Turning your Defender on and off

Simply press the power button.

- Press the **On/Off** button for 1 second to turn on your Defender.
- When first turned on, your Defender displays an opening screen showing the product name, model number and flow range.
- Press the **On/Off** button for 3 seconds to turn your Defender off.

2.3 Connections

Attaching your Defender to a device

Connect device to be calibrated to the appropriate Defender port. Use ¼" I.D tubing.

- Connect tubing to outlet at top (suction fitting) when a device draws air (such as sampler).
- Connect tubing to bottom inlet (pressure fitting) for devices that push air in (pressure devices).

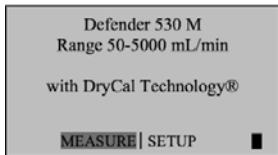

2.4 Display Screen

Understanding the screen components

The Defender 530 provides a menu of operational settings and commands. The four directional arrow buttons on the control panel allow you to navigate through the menu and select the desired settings for your Defender. Your location within the menu is highlighted for easy identification.

2.5 Menu Navigation

Moving through operational menus

- Use the directional arrows ▲, ▼, ► and ◀ on the control panel to find your way through the menu.
- When your desired command is highlighted, simply press the **Enter** button on the control panel.

If you see a menu selection within angle brackets (<....>), that means you have multiple options for an item. Press the left or right (◀or ▶) arrow button to see the options.

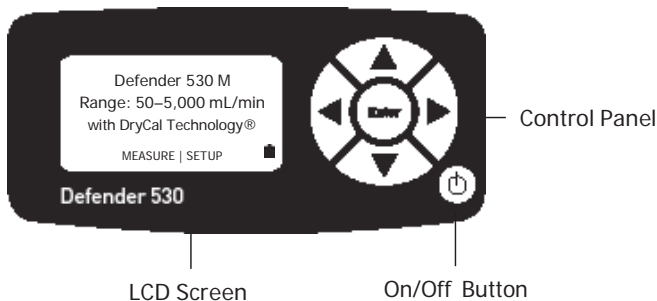

2.6 Set-up

Customizing the Defender to your needs

You can customize your Defender in the **SETUP** menu. Highlight **SETUP** in the introduction screen to enter the Setup Menu. Or, highlight **SETUP** after resetting and then exiting a measurement mode screen. The **SETUP** menu has eight submenus.

- Readings
- Date
- Diagnostics
- Units
- Preferences
- About
- Time
- Power

To select a submenu, use the directional arrow buttons to highlight the submenu and press the **Enter** button.

In submenus, brackets (i.e., <...>) indicate different selection options. You can switch back and forth by pressing the forward or backward (◀ or ▶) arrow.

Highlight **CONFIRM** after making changes and press the **Enter** button to save the changes made.

'**Confirmed, New Settings Will be Retained**' message will appear in the screen for a brief period before it returns to **SETUP** menu.

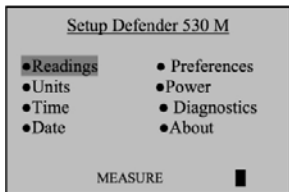

Highlighting **EXIT** and then pressing the **Enter** button will return you to the **SETUP** menu without saving any submenu changes.

Readings

Choose the flow reading type to either volumetric '**Vol**' or standardized '**Std**'. Volumetric flow is the actual flow at the ambient temperature and pressure whereas the standardized flow indicates a flow rate at a specific temperature and pressure. Standardizing pressure is set to a default value of 760 mmHg whereas standardizing temperature is an user settable value set at '**Std To**' in the '**Units**' sub-menu.

Choose the number of measurements in the average from one to 100.

If you wish to incorporate a time delay between consecutive measurements, set **Time Between** from one to 60 minutes.

Set the Sensor Factor to any value between 0.200 to 3.000. Sensor factor scales the reading for calibrating MFCs and MFM with surrogate gases. Sensor factor affects the flow rate measurement only when the reading '**Type**' is set to standardized '**Std**'.

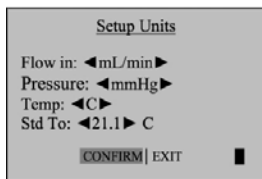
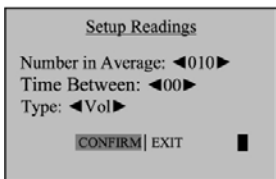

Units

Measure gas **Flow in** cubic centimeters, milliliters, liters or cubic feet (all units are per minute).

Measure **Pressure** in mmHg, kPa or PSI and measure **Temperature** in degree Celsius or Fahrenheit.

Set the standardizing temperature by setting '**Std To**' to a value from 0 to 50 deg C or 32 to 122 deg F. '**Std To**' effects the flow rate measurement only when the reading '**Type**' in the '**Reading**' sub-menu is set to standardized '**Std**'.

Time

Set the current time and the format.

The format can be selected as **PM**, **AM**, or **24H**.

Setup Date

Month: <05>
Date: <10>
Year: <2008>
Format: <DD-MM-YYYY>

CONFIRM | EXIT

Setup Time

Hour: <05>
Minutes: <10>
Format: <PM>

CONFIRM | EXIT

Date

Set the date and the format.

The format can be selected as **DD (day)-MM (month)-YYYY (year)** or **MM (month)-DD (day)-YYYY (year)**.

Preferences

“Read Default”

Allows you to select a preferred mode of measurement when the Defender is initially turned on.

“Default Settings”

Default Settings” - Select <No> to allow the ‘Read Default’ change. Selecting <Yes> will reset your Defender to the factory default settings. See Section 8.0 for the Factory Default Settings.

“Data Port”

Set the Data Port interface by selecting:

<Bios> to operate with DryCal Pro Software or

<SKC> to operate with SKC Calcheck® Interface

“Magnification”

It controls the amount of data on the display; select <Zoom> to view only flow measurements in larger font, or select <Detail> to simultaneously view flow measurements, temperature, and pressure in a smaller font.

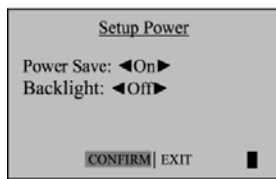
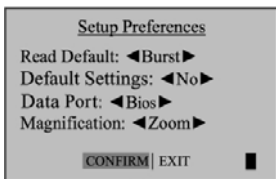

Power

“Power Save”

Select <On>, your Defender will save power by turning off after five minutes of inactivity. However, it will not turn off when connected to the AC power adapter/charger.

Select <Off>, and your Defender will remain on until you manually turn it off.

“Backlight”

Select <On> to illuminate the LCD display or <Off > to conserve battery power.

Diagnostics

The Defender leak test is designed only to verify the internal integrity of the instrument and alert you to an internal leak. We recommend performing the Leak Test only as an intermediate quality control check or whenever the integrity of the instrument is questioned due to misuse or accidental damage.

Please note, it is not a substitute for a comprehensive examination of the unit's overall performance and it does not ensure that your Defender is operating accurately.

- Invert your Defender and allow the piston to travel to the top.
- Cap the port under test using the supplied leak test cap. Leave the other port uncapped.
- Press **Enter** on the control panel while the unit is still inverted.
- Return the unit upright. The leak test will progress.

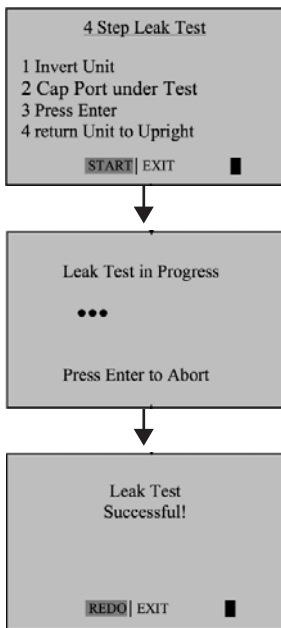

About

Tells you more about your Defender; a useful screen to refer to when speaking to a technical support representative or your Mesa distributor.

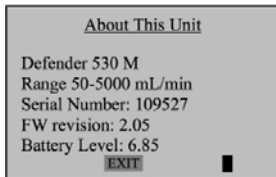

Out of Range!

If the flow you are measuring is outside the Defender's flow range, the "Out of Range!" warning appears. Immediately lower or disconnect the flow. When the flow is within the proper range, select RESET to clear your Defender's last measurement.

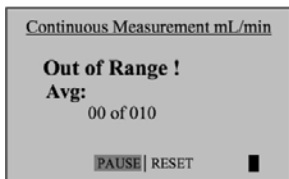

2.7 Measurements

Taking gas flow readings

To maintain the best possible accuracy and minimize thermal effects, Mesa recommends fully charging your battery before taking measurements. If this is not possible, we recommend disconnecting your Defender from its AC power adapter/charger while taking flow measurements — or to run gas through your Defender for 10 minutes before starting the flow measurement.

First steps

- Press the **On/Off** button for 1 second to turn on your Defender
- When first turned on, your Defender displays an opening screen showing the product name, model number and flow range
- Press the **On/Off** button for 3 seconds to turn your Defender off

Connect device to be calibrated to the appropriate Defender port.

- Connect tubing to outlet at top (suction fitting) when a device draws air (such as sampler)
- Connect tubing to bottom inlet (pressure fitting) for devices that push air in (pressure devices)
- Do not cap the unused port on the Defender
- Select the reading type to **Vol** or **Std**. Set '**Std To**' to the desired standardizing temperature
- Choose the measurement type to **Single**, **Burst**, or **Continuous** and then press **Enter**

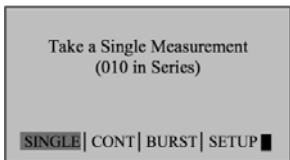

2.8 Single Measurement

Each time the '**Enter**' button is pressed, one measurement will be made. When each subsequent measurement is made, the current flow and average of prior readings will be displayed.

2.9 Burst Measurement

This setting functions in the same manner as '**SINGLE**', but measurements continue automatically until the preset number of measurements has been made. Operation then ceases and the last reading and average are displayed.

Press '**Enter**' again, another preset sequence begins.

2.10 Continuous Measurement

This setting functions in the same manner as '**BURST**', but new sequences will automatically repeat until stopped by the user.

Note:

(010 in series) indicates the number of measurements. 10 is factory-preset number. You can define the number of measurement you preferred from 1 to 100 by accessing the **SETUP** menu.

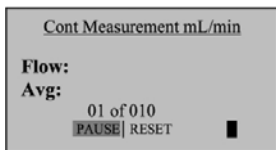

In Continuous or Burst mode, select:

- **PAUSE** to terminate the current flow measurement but to leave the average flow measurement and previous flow measurement on the screen. This allows you to resume the flow measurement sequence if you wish to do so.
- **RESET** to terminate the flow measurement and clear the screen.

3.0 Data Port

3.1 Bios DryCal Pro Software

Visit Mesa's website to download your copy of DryCal Pro software (<http://www.mesalabs.com/drycal-pro/>) . DryCal Pro captures flow data from your Defender directly to a pre-configured table. The data can be exported to selectable Microsoft office environment.

To run DryCal Pro, you must have Windows® XP or 7, Microsoft Excel® 2003 and up, and a RS232 port, or if your PC does not have an RS-232 port you will need a USB to RS-232 adapter.

3.2 Defender Firmware Upgrades

The Defender firmware is upgradable through the Data Port. Contact technical support for more information (biosdrycal@mesalabs.com).

4.0 Annual Maintenance and Calibration

Assuring top performance and accuracy

Your Defender is a precision measuring standard with moving parts machined to extremely close tolerances. Various environmental factors, product wear, drift of sensors, or inadvertent damage may adversely affect your Defender's measurement accuracy or general performance. For these reasons, Mesa Labs highly recommends having your Defender annually verified by an ISO 17025–accredited laboratory, such as our Butler, NJ site, to ensure its measurement integrity.

For the ultimate in Defender maintenance and to take advantage of any available firmware and mechanical upgrades, Mesa Labs offers an annual non-mandatory Recertification program. This is a service package that provides complete product refurbishment, testing and available upgrades; calibration and NIST-traceable calibration certificates.

Recertification includes a 90-day service warranty should any related labor or parts replacements prove faulty.

Turnaround time is generally two weeks from time of receipt. Expedited **48-hour** turnaround is available.

3.0

4.0

5.0 Shipping

Tips and guidelines for sending your Definer to Mesa

If you are sending your Defender for repair or evaluation (rather than elective Recertification),

- Contact Mesa Labs for technical support or troubleshooting assistance prior to shipping the unit. Provide us a detailed description of your issue(s).
- If we are unable to resolve the situation by phone or email, we will issue you an RMA (return merchandise authorization) number. Follow online instruction for proper return procedure.

You can obtain an RMA number through our website **drycal.mesalabs.com**, emailing **csbutler@mesalabs.com** or by telephone at **973.492.8400**.

Note: Mesa Labs will not evaluate or service your instrument without an RMA number.

If we find the issues in concern are application related and not product related, an evaluation fee will be charged.

Shipping

When shipping your Defender

- Use adequate packing material. Whenever possible, use the original packing that came with your Defender. Or use a Pelican carrying case, which provides a hard case shell for protection of your valuable equipment.
- Use a major freight carrier (e.g., FedEx, UPS) that supplies tracking numbers.
- Insure your Defender. Mesa Labs is not responsible for damage occurred during transit.
- Understand our mutual shipping obligations.

6.0 Storage

Protecting your Defender when not in use

If you need to store your Defender for an extended period, please follow these guidelines:

1. Always store it in a clean, dry place.
2. If possible, leave it attached to its AC power adapter/charger while in storage.
3. If your Defender cannot be attached to its AC power adapter/charger while in storage, please do the following:
 - Fully charge it before extended storage. If the battery is not fully charged prior to storage, it might be permanently damaged.
4. Fully charge it at least once every three months.
5. Recharge the battery for at least 8 hours prior to reusing your Defender after storage.

7.0 Defender 530 Series Specifications

Technical data about your Defender

Models:

530L, from 5-500 scc/min

530M, from 50-5,000 scc/min

530H, from 300-30,000 scc/min

Measurements:

Standardized Accuracy: $\pm 1.2\%$ of reading

Volumetric Accuracy: $\pm 1\%$ of reading

Time per Measurement: 1-15 seconds (approximate)

Type: Single, Continuous or Burst

Volumetric Flow Units: cc/min, mL/min, L/min, cf/min

Standardized Flow Units: scc/min, smL/min, sL/min, scf/min

Pressure Units: mmHg, PSI, kPa

Temperature Units: °C, °F

Basics:

Dimensions (H x W x D): 5.5 x 6 x 3 in / 140 x 150 x 75 mm

Weight: 29 oz / 820 g

Configuration: Integrated flow measuring cell,
valve and timing mechanism

Temperature & Pressure Sensors:

In the flow stream

Press Accuracy: 3.5 mmHg (typical), 7.0 mm (max);

Temp Accuracy: 0.8° C (typical), 1.3° C (max)

AC Power Adapter/Charger: 12VDC, >250ma, 2.5 mm, center

6.0

7.0

positive

Battery: 6V rechargeable, sealed lead-acid, 6-8 hours typical operation

Battery Operational Time (5 cycles/min): 3 hrs backlight on, 8 hrs backlight off

Pressure & Suction Fittings: ¼" ID barbed tube

Display: Backlit graphical LCD

Usage:

Flow Modes: Suction or Pressure

Operating Pressure (Absolute): 15 PSI

Operating Temperature: 0-50° C

Ambient Humidity: 0-70%, non-condensing

Storage Temperature: 0-70 °C

Warranty: 1 year; battery 6 months

DryCal Pro Software:

DryCal Pro Software System Requirements

- Windows® XP, Windows® 7
- Microsoft Excel® 2003 and up
- RS-232 port, or if your PC does not have an RS-232 port you will need a USB to RS-232 adapter

8.0 Factory Default Settings

The Defender is set with the following Default settings from the factory:

- **Reading Type** – Vol
- **Number in Average** – 10
- **Time Between** – 0
- **Flow Units** – cc/min
- **Pressure Units** – mmHg
- **Temperature Units** – C
- **Standardizing Temp** – 21.1 C
- **Measurement Mode** – Single
- **Magnification** – Zoom
- **Backlight** – On
- **Power Save** – On
- **Time Format** – 24H
- **Date Format** – MM-DD-YYYY

9.0 Limited Warranty

The Defender 500 Series is warranted to the original end user to be free from defects in materials and workmanship under normal use and service for a period of one year from the date of purchase as shown on the purchaser's receipt. The Defender 500 Series' battery is warranted for six months from the original purchase date. If the unit was purchased from an authorized reseller, a copy of an invoice or packing slip showing the date of purchase may be required to obtain warranty service.

The obligation of Mesa Laboratories, Inc. under this warranty shall be limited to repair or replacement (at our option), during the warranty period, of any part that proves defective in material or workmanship under normal use and service, provided the product is returned to Mesa Laboratories, Inc., transportation charges prepaid.

Notwithstanding the foregoing, Mesa Laboratories, Inc. shall have no liability to repair or replace any Mesa Laboratories, Inc. product:

1. That has been damaged following sale, including but not limited to damage resulting from improper electrical voltages or currents, defacement, misuse, abuse, neglect, accident, fire, flood, terrorism, act of God or use in violation of the instructions furnished by Mesa Laboratories, Inc.
2. When the serial number has been altered or removed.
3. That has been repaired, altered or maintained by any person or party other than a Mesa Laboratories, Inc. service facility or a Mesa authorized service center, should one be established

This warranty is in lieu of all other warranties and all other obligations or liabilities arising as a result of any defect or deficiency of the product, whether in contract or in tort or otherwise. All other warranties, expressed or implied, including any implied warranties of merchantability and fitness for a particular purpose, are specifically excluded.

In no event shall Mesa Labs be liable for any special, incidental or consequential damages for breach of this or any other warranty, express or implied whatsoever.

10.0 Troubleshooting Guide

Mesa is ready to help you with any operational issue you may encounter with your Defender. However, we may be able to save you some time by providing a short checklist of the questions most commonly asked of our customer service and technical specialists.

Why won't my Defender turn on?

If the Defender will not turn on, verify that the battery has been charged. When connected to the AC power adapter/charger and power is present, a small green indicator light should be visible through the front viewing window.

My Defender won't respond to push-button commands

If the Defender fails to respond to push-button commands, you can perform a hard reset of the Defender. This can be done by inserting a paper clip into the reset opening in the back of the unit.

I am not sure I have my Defender connected properly

Verify that the flow source is connected to the pressure port of your Defender for pressure sources or to the suction port for verifying suction pumps. The unused port should be at atmospheric pressure with any cap or plug removed. If you are calibrating a gas that requires an exhaust line to vent the measurement gas, ensure that the tubing is of sufficient diameter not to create a

pressure drop greater than 5 inches of water.

How do I protect against leaks?

Ensure that the hose and tube fittings are tight and leak free.

The tubing connecting your flow source (pump, mass flow controller, needle valve, sonic nozzle or restrictor) to the meter should be kept as short as possible.

What do I do when my leak test fails?

First check to make sure that the leak test cap is on correctly and it is not leaking through the leak test cap itself. If the leak test cap is correct, perform leak test both at the pressure and at suction side. If it fails, contact technical support.

What is the best way to connect to the filter medium?

When calibrating sampling pumps, best results are obtained with the filter medium connected to the pump and the Defender's suction port connected to the inlet side of the filter medium with a short piece of tubing.

Why am I experiencing a temperature increase in my Defender 530?

A temperature rise during initial battery charging, or while charging a fully discharged battery is normal. To maintain the best

possible accuracy, Mesa recommends fully charging your battery before taking measurements. If this is not possible, we recommend disconnecting your Defender from its AC power adapter/charger while taking flow measurements- or to run gas through your Defender for 10 minutes before starting the flow measurement.

Why doesn't my piston return to the bottom of the cell?

If the piston fails to return to the bottom of the cell after a measurement, this could be caused by:

- A discharged battery not providing enough power to operate the internal valve properly (try charging the Defender).
- Bright light shining into the unit resulting in an overload of the internal optical sensors (try to operate the unit in a shaded location).
- Moisture or dirt inside the cell (return the Defender to Bios for service).

What is dead volume?

Dead volume is the gas volume between a flow generator and the instrument taking the measurement. Since gas is compressible, this gas can act as a spring between the flow source and the measurement instrument. For best accuracy, this volume should be kept to a minimum.

We recommend keeping the tubing length between the gas flow generator and your Defender to no more than 0.5 meters/20 inches in length.

What is the difference between volumetric flow and standardized flow?

As we know from the ideal gas law, the volume of a gas changes with a change in temperature or pressure even when the number of molecules which constitute the mass remains the same.

Volumetric flow rate is the rate at which a volume of a gas travels past a given location. **Volumetric Flow = As Measured Volume of Gas / Time**

Standardized (mass) flow rate is expressed as the rate at which the volume of a gas travels past a given location if the gas is at a specified temperature and pressure. From the ideal gas law if the temperature and pressure are held constant, the volume of the gas is proportional to the number of molecules.

Standardized Flow = Volume of Gas (at the standard temperature and pressure) / Time

Our Commitment to You

We strive to provide the closest NIST-traceable, legal defensibility of any flow calibration equipment manufacturer, and we actively maintain our NVLAP (NIST) ISO 17025 laboratory accreditation in order to support our claims and continually improve our quality system and laboratory proficiency. Thank you for purchasing our products. From all of us at Mesa, best wishes for many years of accurate, defensible primary flow measurements.



Mesa Laboratories, Inc.

12100 West 6th Avenue

Lakewood, CO 80228

Phone: 973.492.8400

Toll Free: 800.663.4977

Fax: 973.492.8270

Email: csbutler@mesalabs.com

web: www.mesalabs.com